

MERCURY INSTRUMENTS Analytical Technologies



SM-4 mobile

Continuous Emissions Monitor for Mercury

Modular demountable Mercury CEM

- Easy transport
- Easy assembly
- Maintenance free converter directly at stack
- Detects elemental, ionic and bound Mercury
- Large measuring range: 0.05 to 1000 $\mu\text{g}/\text{m}^3$



Introducing the **SM-4 mobile** by Mercury Instruments

Mercury Instruments **SM-4 mobile** has been developed on the basis of the well proven stationary SM-4 CEM.

Due to its modular design, the **SM-4 mobile** can easily be transported, assembled and disassembled. It is the ideal solution for the determination of total vapor phase mercury emissions at varying sites.

Typical industries for use of the **SM-4 mobile** include coal fired power stations, waste incinerators, cement kilns and all other plants generating process gases which contain mercury traces in a complex matrix.



**Fits in almost every
Van or Station-wagon**



Applications

- **Testing of permanent CEMs for compliance monitoring**
- **Method 30A applications**
- **Mercury control technologies optimization**
- **Mercury stack testing**

Technology

The heated sampling probe is mounted at stack. Sample gas is continuously drawn into a dilution unit by a maintenance free ejector pump, passing a heated particle filter. A critical orifice stabilizes the sample flow thus making it independent of the pressure existing in the stack. The suction vacuum is continuously controlled by a sensor which guarantees correct function of the sample dilution. A partial flow of the diluted sample is passed through the catalyst where mercury is converted into the elemental state. Subsequently the sample is transported through a sample line to the mercury detector which may be tens or even some hundreds of feet away from the sampling probe. The detector uses a pre-concentration technique with the unique Mercury Instruments GoldTrap, thus making the **SM-4 mobile** one of the most sensitive mercury detectors in the market.

Thermocatalytic Converter

Mercury present in stack gases is usually not only elemental but may also be ionic or bound mercury. In order to measure total mercury all these different mercury species have to be converted into the elemental form.

For this the **SM-4 mobile** utilizes a dry thermo-catalytic method working at low temperatures.

The advantages of a low temperature converter are fast heating up and cooling, low power consumption and the fact that materials like FKM (Viton®), PTFE (Teflon®) or silicone can be used.

The catalyst ensures that even under presence of oxidising matrix components the mercury conversion is 100 % complete.

Sampling Probe

The sampling probe is an important part of the whole system as it has to extract a representative part of the sample gas and to supply it to the sample conditioning system. Sample wetted parts are made of Teflon® or silica coated stainless steel, guaranteeing a minimum affinity to mercury.

The particle filter is automatically cleaned. An automatic valve allows to introduce calibration gas upstream the sample filter.

Prevention of Interferences

Mercury measurement is commonly interfered by SO₂, NO_x, HCl, VOC's. Amalgamation alone, however, reaches its limits when the gold surface is affected by matrix constituents, whereas sample dilution alone may not be sufficient to cut down interferences to a tolerable level. The **SM-4 mobile** uses both: sample dilution and GoldTrap amalgamation for a complete elimination of interferences.

Automatic Calibration

SM-4 mobile is packaged with a NIST Certified Calibrator which allows automatic and manual calibrations and span checks. It does not require refilling.



Every component can easily be carried by two people

Features and Benefits of the SM-4 mobile

- Dry thermo catalytic method, no need for reagents, water refills or replacements of solid reagent cartridges
- Sample dilution which eliminates interference from matrix gases like SO₂, HCl, NO_x
- Extreme high sensitivity providing a low measuring range limit of 0.05 µg/m³
- Automatic blow back of particulate filter
- Fast response: t(90) time typically 180 seconds
- Sample line length up to 240 feet
- Calibration gas generator integrated (NIST certified)

System components:

Sampling probe with dilution and converter unit

Probe controller box

Heated bundle containing sample line, air supply line, calibration gas feed line

Analyzer cabinet with detector and calibrator

Air conditioning cabinet with pressure gauges, air filters, membrane dryer

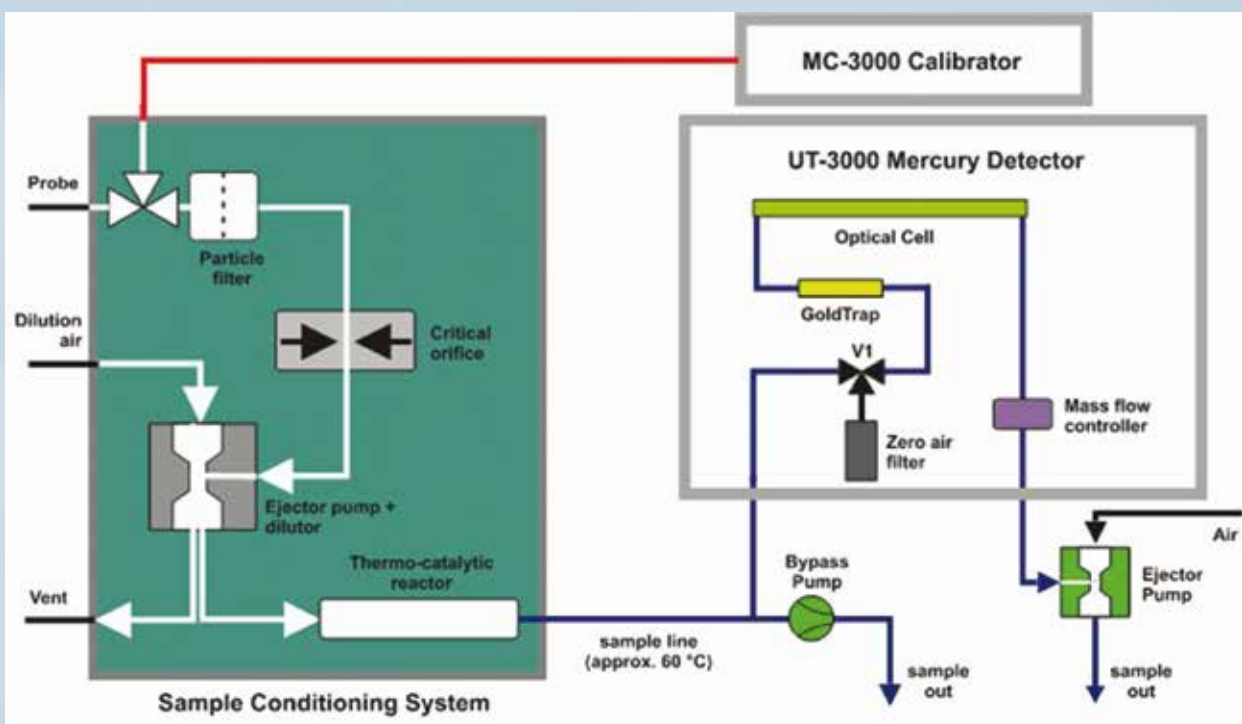

Technical Specifications SM-4 mobile

Measurement technique	Dilution probe with thermo-catalytic converter at stack, fast loop to analyzer unit, atomic absorption detector with GoldTrap
Principle of measurement	Cold Vapor Atomic Absorption Spectrometry (CVAAS) with amalgamation, wavelength 253.7 nm
Measured component	Total Hg
Measuring range	0.05 µg/m ³ to 1000 µg/m ³ Hg
Detection limit	0.0001 µg/m ³ (detector); <0.05 µg/m ³ (system)
Response time	Typically 180 sec
Max. sample temperature	250 °C (482 °F); high temperature probe as option for sample temperature up to 1000 °C (1800 °F)
Ambient temperature range allowed	-5 °C to 40 °C (23 °F to 104 °F)
Sample line length	Up to 90 m (240 ft)
Signal output	4-20 mA (500 Ohm); RS232; modbus RTU/RS485 (option); ethernet (option)
Status output	3 x pairs of relay contacts (dry contacts)
Remote access	Modem and software (option)
Electrical power consumption	230 VAC or 115 VAC/50-60 Hz
Dimensions	Analyzer box I: 60 x 60 x 60 cm (23.6" x 23.6" x 23.6") HxWxD Analyzer box II: 73 x 60 x 60 cm (28.7" x 23.6" x 23.6") HxWxD Probe: 75 x 38 x 34 cm (29.5" x 15" x 13.4") HxWxD Probe controller: 48 cm x 44 cm x 27 cm (18.9" x 17.3" x 10.6") HxWxD
Weight	Analyzer box I: 50 kg (110 lbs) Analyzer box II: 50 kg (110 lbs) Probe controller: 12 kg (27 lbs) Probe converter unit: 30 kg (66 lbs)
Air consumption	6 bar (87 PSI); peak 35 l/min (1.2 scfm)
Calibration / span check	Automatically, with integrated calibration gas generator (NIST certified)

Advantages of Atomic Absorption with Amalgamation:

- No carrier gas needed
- Higher sensitivity than systems without gold trap
- AA is not prone to quenching effect
- No compensation or background correction provisions required
- Allows components like SO₂, O₂, NO_x and organics to be present at levels 1000 to 10000 times higher than mercury
- No zero drift due to amalgamation technique with Auto-Zero
- Linear range over five orders of magnitude



Mercury Instruments GmbH
Analytical Technologies
Liebigstrasse 5
85757 Karlsfeld/Germany

mail@mercury-instruments.de

Tel.: +49(0)8131 - 50 57 20

Fax.: +49(0)8131 - 50 57 22

Distributed by:

www.mercury-instruments.de